

Pick to light

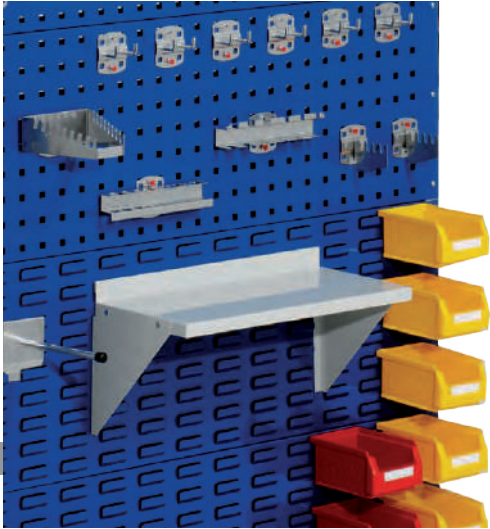

Accessori



ERGONOMIA



Sedute ergonomiche



- **Qualità**
- **Anti-fatica**
- **ESD**



UT-BOX

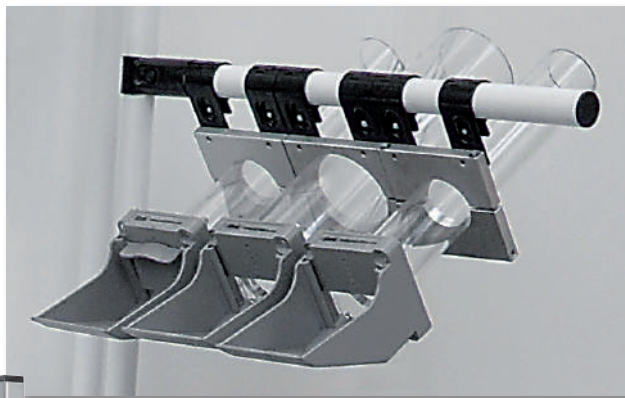

Pedane ergonomiche

Pedane ergonomiche

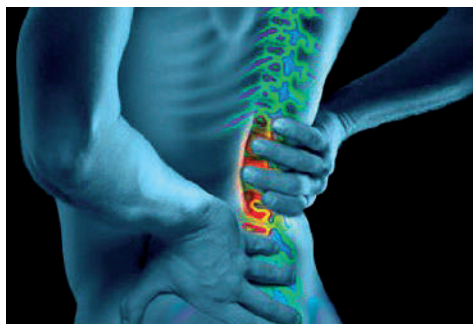

Ergonomia, Sicurezza e Pulizia.

Tappeti realizzati per ridurre la fatica sia posturale che dei piedi, per migliorare la sicurezza aumentando l'attrito sulle diverse superfici, riducendo la possibilità di cadute e per ottimizzare la pulizia dei luoghi di lavoro.

DESCRIZIONE E MODELLI

Dimensione standard 900x600mm. Altre misure su richiesta.

Pedane Ergonomiche caratterizzate da poliuretano a bassa densità e da un disegno ergonomico.

240



COMFORT STANDARD



COMFORT DREHFIT



COMFORT DUOFIT



CLASSIC PUR



CLASSIC DREHFIT



HYDROFIT

Queste pedane ergonomiche sono progettate per migliorare la qualità e l'ergonomia del posto di lavoro per qualsiasi tipologia di ambiente, riducendo i dolori muscolari, le sollecitazioni a schiena gambe e piedi.



COMFORT



DREHFIT



HYDROFIT

Ampia gamma di pedane ergonomiche mirate per le più disparate applicazioni, resistenti al usura, oli, sostanze chimiche ecc..

Qualsiasi dimensione e forma ad un unico prezzo grazie alla loro modularità.

Caratterizzate da un bordo esterno smussato.



DESCRIZIONE E MODELLI



Utilizzo	In aree bagnate e asciutte	In aree bagnate e asciutte. Per luoghi di lavoro che richiedono frequenti rotazioni	In aree bagnate e asciutte
Materiale	I Poliuretano su base polietere	Poliuretano su base in polietere	Poliuretano su base in polietere
Superficie	Bugnato	Superficie bugnata appiattita	Zigrinata
Lato inferiore	Liscio	Liscio	Superficie zigrinata per il massimo comfort in piedi e protezione antiscivolo
Peso (Kg)	3	3	3
Spessore (mm)	14	12	14
Resistenza alla temperatura	da -35 °C a +95 °C	da -35 °C a +85 °C	da -35 °C a +95 °C
Resistenza elettrica (modello ESD)	10 ⁶ Ω	10 ⁶ Ω	10 ⁶ Ω
Ritardante di fiamma	Classe di fuoco: B1 secondo DIN 4102/ FMVSS 301	Classe di fuoco: B1 secondo DIN 4102/ FMVSS 301	Classe di fuoco: B1 secondo DIN 4102/ FMVSS 301
Colore	Grigio	Grigio	Grigio
Nome	COMFORT STANDARD	COMFORT DREHFIT	COMFORT DUOFIT

241



Utilizzo	Principalmente in aree asciutte	Principalmente in aree asciutte. Per luoghi di lavoro che richiedono frequenti rotazioni	Principalmente in aree asciutte
Materiale	Poliuretano	Poliuretano	Poliuretano
Superficie	Bugnato	Superficie bugnata appiattita	Zigrinata
Lato inferiore	Liscio	Liscio	Superficie zigrinata per il massimo comfort in piedi e protezione antiscivolo
Peso (Kg)	3	3	3
Spessore (mm)	14	12	14
Resistenza alla temperatura	da -40 °C a +80 °C	da -40 °C a +80 °C	da -40 °C a +80 °C
Resistenza elettrica (modello ESD)	10 ⁶ Ω	10 ⁶ Ω	10 ⁶ Ω
Colore	Grigio	Grigio	Grigio
Nome	CLASSIC PUR	CLASSIC DREHFIT	CLASSIC DUOFIT

Ergonomia

ERGONOMIA



Utilizzo	Per luoghi di lavoro esposti ad acqua, olio, trucioli e schegge	Per aree di preparazione di cibo secco e umido, OP, laboratorio o aree di igiene
Materiale	Nitrile, NBR	Nitrile, NBR
Superficie	Bugnato	Bugnato
Lato inferiore	Lato inferiore strutturato per una migliore adesione, effetto idrorepellente	Lato inferiore strutturato per una migliore adesione, effetto idrorepellente
Peso (Kg)	5,7	6,7 (nero), 5,8 (grigio chiaro)
Spessore (mm)	14,5	14,5
Resistenza alla temperatura	fino a +100 °C per brevi periodi	+96°C per 8 ore
Resistenza elettrica (modello ESD)	10 ⁶ Ω	
	Resistente ai comuni acidi industriali, basi, oli, resistente all'idrolisi. Adatto per stazioni di saldatura	
Colore	● Nero	● Nero ● Grigio
Nome	HYDROFIT NBR	FOOD-GRADE MAT



Pannelli perforati

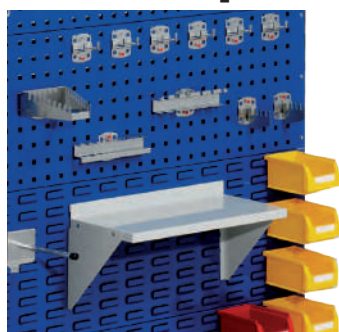

I nostri sistemi Shadow Board permettono di mantenere ogni utensile o attrezzatura al proprio posto offrendo varie possibilità d'impiego, come soluzioni a parete o pannelli da montare su workstation tra i montanti dei banchi di lavoro.

I pannelli perforati sono realizzati in lamiera d'acciaio, 1,25 mm di spessore e rivestimento plastico resistente agli urti e ai graffi.

Colore standard: grigio chiaro.
Altri colori su richiesta.

DESCRIZIONE MODELLI

Pannelli perforati in acciaio

Colore	500 x 450	1000 x 450	1500 x 450	2000 x 450
Azzurro chiaro	SB500-01	SB1000-01	SB1500-01	SB2000-01
Azzurro	SB500-02	SB1000-02	SB1500-02	SB2000-02
Blu	SB500-03	SB1000-03	SB1500-03	SB2000-03
Verde	SB500-04	SB1000-04	SB1500-04	SB2000-04
Rosso	SB500-05	SB1000-05	SB1500-05	SB2000-05
Giallo	SB500-06	SB1000-06	SB1500-06	SB2000-06
Grigio chiaro	SB500-07	SB1000-07	SB1500-07	SB2000-07
Grigio	SB500-08	SB1000-08	SB1500-08	SB2000-08
Nero	SB500-09	SB1000-09	SB1500-09	SB2000-09
Bianco	SB500-10	SB1000-10	SB1500-10	SB2000-10

243



Set di ganci per pannelli perforati

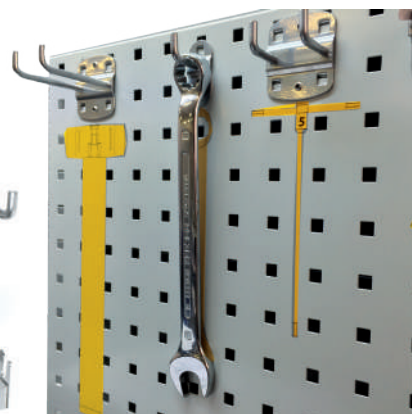
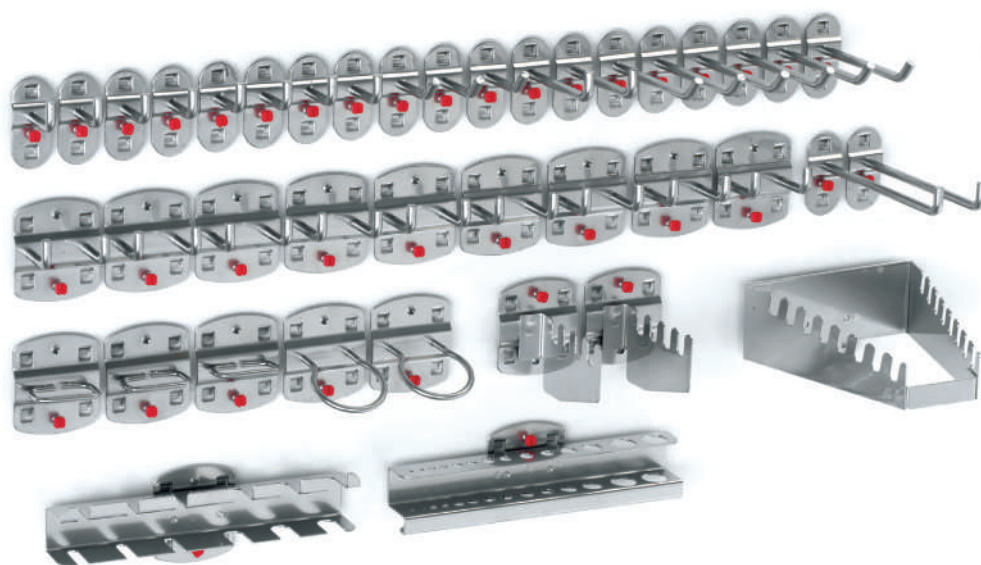

Sagome utensili TPM

Vedi pag. 159

244

Utek ti propone un'ampia gamma di accessori per la progettazione su misura di pannelli modulari forati:

- Ganci per appendere utensili di diverse dimensioni e volumi e per il supporto di cassette portaminuterie
- Accessori per l'organizzazione del lavoro come porta cestino dei rifiuti o portarotoli per materiale da imballo
- Mensole e ripiani per avvicinare e portare ad altezza ergonomica contenitori e materiali utili al lavoro.

I ganci per pannello portautensili possono essere sia bloccati nei pannelli forati, sia avvitati a parete

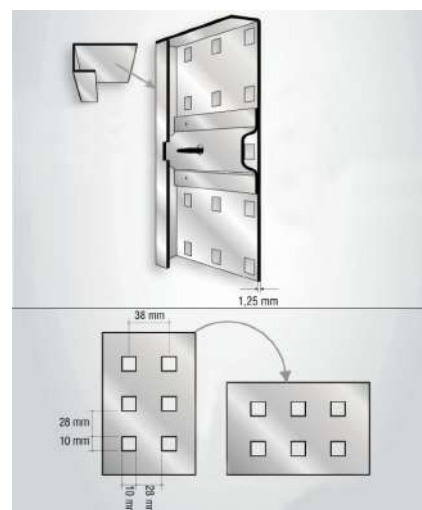

Ganci per pannelli forati caratteristiche:

- Nucleo in acciaio 1,5 mm
- Rivestimento plastico per maggiore resistenza a urti e graffi
- Disponibili color alluminio o antracite per maggiore pulizia e organizzazione visiva
- Vite rossa in poliammi

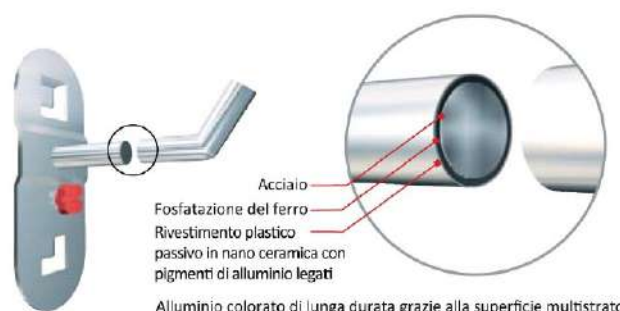

Set completi di ganci portautensili in differenti combinazioni



SGN-KIT10

Cod. Ganci del Kit	Qtà / Gancio
SGN-012	1
SGN-001	7
SGN-020	2

SGN-KIT12



Cod. Ganci del Kit	Qtà / Gancio
SGN-005	4
SGN-002	3
SGN-033	1
SGN-030	1
SGN-020	3

SGN-KIT15



Cod. Ganci del Kit	Qtà / Gancio
SGN-001	8
SGN-012	1
SGN-020	3
SGN-032	1
SGN-064	1
SGN-071	1

245

SGN-KIT17



Cod. Ganci del Kit	Qtà / Gancio
SGN-012	4
SGN-013	1
SGN-001	4
SGN-002	4
SGN-020	4

SGN-KIT18



Cod. Ganci del Kit	Qtà / Gancio
SGN-012	2
SGN-013	1
SGN-001	5
SGN-006	2
SGN-034	2
SGN-021	3
SGN-067	1
SGN-064	1
SGN-071	1

SGN-KIT20



Cod. Ganci del Kit	Qtà / Gancio
SGN-012	5
SGN-005	5
SGN-022	5
SGN-067	1
SGN-046	2
SGN-066	1
SGN-069	1

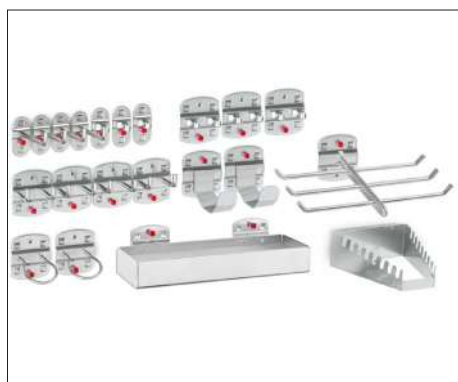

SGN-KIT21

Cod. Ganci del Kit	Qtà / Gancio
SGN-006	4
SGN-013	3
SGN-042	3
SGN-020	4
SGN-027	2
SGN-030	2
SGN-054	1
SGN-071	1

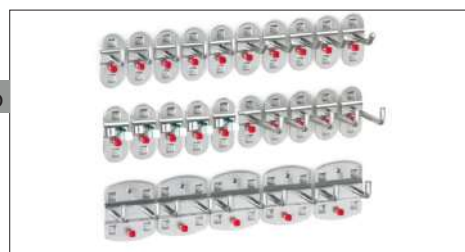

SGN-KIT25

Cod. Ganci del Kit	Qtà / Gancio
SGN-005	5
SGN-001	5
SGN-038	5
SGN-006	5
SGN-020	5



SGN-KIT28

Cod. Ganci del Kit	Qtà / Gancio
SGN-005	4
SGN-001	3
SGN-006	2
SGN-002	3
SGN-007	2
SGN-019	6
SGN-033	2
SGN-030	1
SGN-046	2
SGN-064	1
SGN-067	1
SGN-071	1

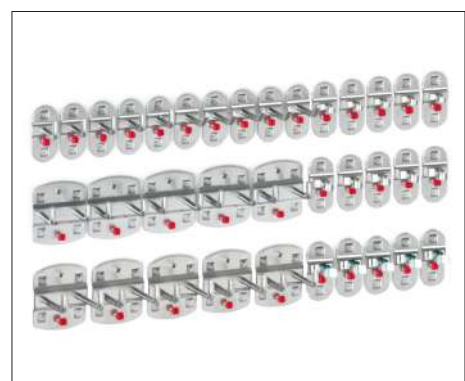

SGN-KIT35

Cod. Ganci del Kit	Qtà / Gancio
SGN-005	5
SGN-001	5
SGN-012	5
SGN-020	5
SGN-014	5
SGN-022	3
SGN-021	2
SGN-016	5

SGN-KIT40



Cod. Ganci del Kit	Qtà / Gancio
SGN-005	8
SGN-001	3
SGN-006	2
SGN-002	6
SGN-019	9
SGN-007	2
SGN-033	3
SGN-030	2
SGN-046	2
SGN-071	1
SGN-064	1
SGN-067	1

247

SGN-KIT42



Cod. Ganci del Kit	Qtà / Gancio
SGN-005	8
SGN-001	3
SGN-012	2
SGN-007	6
SGN-019	9
SGN-033	2
SGN-014	3
SGN-021	2
SGN-031	2
SGN-034	1
SGN-071	1

Accessori per pannelli perforati



Gancio, estremità obliqua

Cod. Art.	L	Ø
SGN-001	50mm	6mm
SGN-002	100mm	
SGN-003	150mm	
SGN-004	200mm	



Piastra per soluzione piccola

Cod. Art.	
SGN-017	piccolo
SGN-018	grande

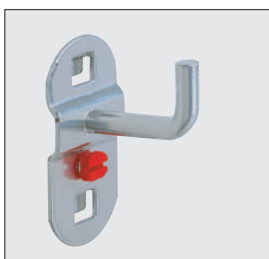

Gancio, estremità dritta

Cod. Art.	L	Ø
SGN-005	35mm	6mm
SGN-006	75mm	
SGN-007	125mm	

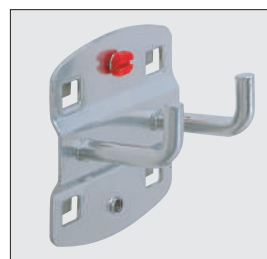

Doppio gancio, estremità dritta

Cod. Art.	L	Ø
SGN-019	35mm	6mm
SGN-020	50mm	
SGN-021	75mm	
SGN-022	150mm	

Ergonomia

Accessori per pannelli perforati

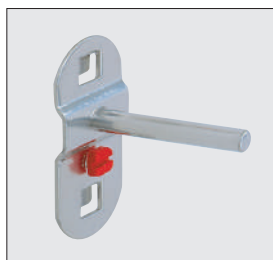

Gancio dritto

Cod. Art.	L	Ø
SGN-008	50mm	6mm
SGN-009	100mm	
SGN-010	150mm	

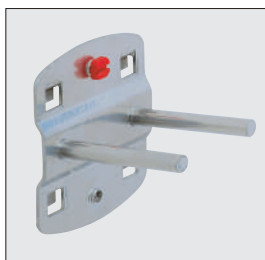

Doppio gancio dritto

Cod. Art.	L	Ø
SGN-023	50mm	6mm
SGN-024	100mm	
SGN-025	150mm	



Gancio obliquo per bussole e chiavi a bussola

Cod. Art.	L	Ø
SGN-011	14/40mm	6mm



Gancio per tubi e chiavi

Cod. Art.	L	Ø
SGN-026	35mm	60mm
SGN-027	35mm	100mm

248

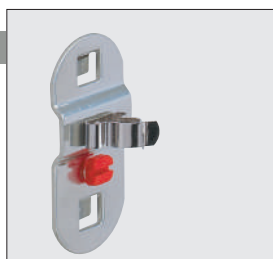

Morsetto piastra piccola

Cod. Art.	Ø
SGN-012	6mm
SGN-013	10mm
SGN-014	13mm
SGN-015	16mm
SGN-016	19mm



Gancio per rocchetti Ø 17 mm, largh. 78 mm

Cod. Art.	Ø
SGN-028	170mm



Anello

Cod. Art.	L	Ø
SGN-029	65mm	25mm

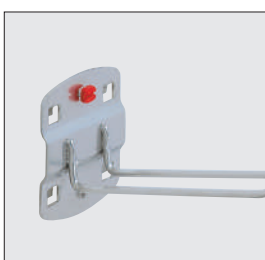

Gancio portautensili

Cod. Art.	L	B
SGN-048	125mm	30mm



Porta-avvitatore

Cod. Art.	Ø interno
SGN-030	40mm
SGN-031	60mm
SGN-032	80mm

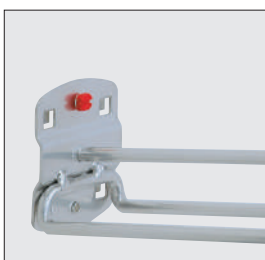

Portautensili, tre ganci

Cod. Art.	L	B
SGN-049	150mm	45mm



Porta-pinze

Cod. Art.	B	T
SGN-033	35mm	20mm
SGN-034	55mm	
SGN-035	75mm	

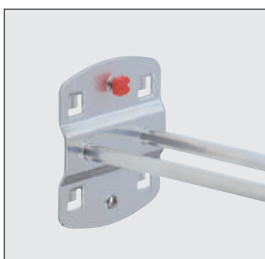

Porta-cavi, altezza estremità 50mm

Cod. Art.	L	B
SGN-050	150mm	37mm
SGN-051	200mm	



Portautensili, piastra grande

Cod. Art.	Ø
SGN-036	25mm
SGN-037	28mm
SGN-038	32mm

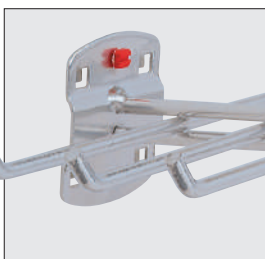

Portautensili, sei ganci

Cod. Art.	L	B
SGN-052	140mm	240mm

Accessori per pannelli perforati



Portabarattoli

Cod. Art.	B	Ø
SGN-039	100mm	70mm



Portautensili magnetico

Cod. Art.	Ø
SGN-040	40mm



Doppio morsetto

Cod. Art.	Ø
SGN-041	6mm
SGN-042	10mm
SGN-043	13mm
SGN-044	16mm
SGN-045	19mm

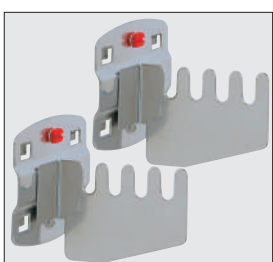

Portaseghe (ordinare a coppia)

Cod. Art.	
SGN-046	per 4 seghe

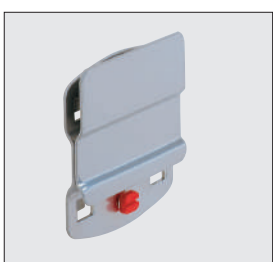

Porta-Bocche di Lupo (Mis. 7 - 8)

Cod. Art.	
SGN-047	(per 1 cassetta)

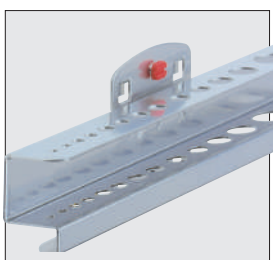

Portautensili per brugole

H 35 x B 200/390 x T 30mm

Cod. Art.	
SGN-059	per 14 pezzi
SGN-060	per 28 pezzi

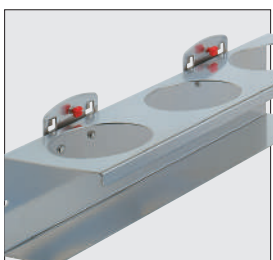

Portautensili per (3) barattoli

Cod. Art.	B	Ø
SGN-061	300mm	70mm

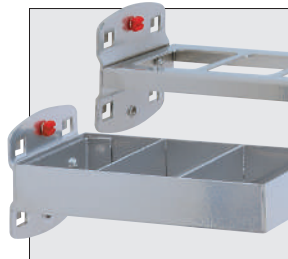

Portautensili combinato, 2 pezzi

Cod. Art.	L	B
SGN-053	150mm	55mm

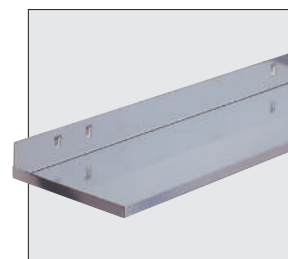

Vaschetta

Cod. Art.	L	T
SGN-054	350mm	125mm
SGN-055	445mm	150mm



Vaschetta, bordo anticaduta

● Grigio Chiaro

Cod. Art.	B	T
SGN-056	490mm	243mm



Mensola

● Grigio Chiaro

Cod. Art.	B	T
SGN-057	435mm	250mm

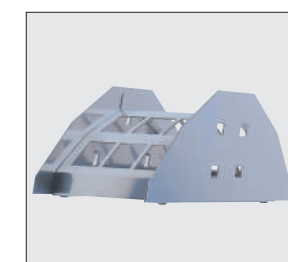

Reggicavi

Cod. Art.	B	T
SGN-058	230mm	125mm

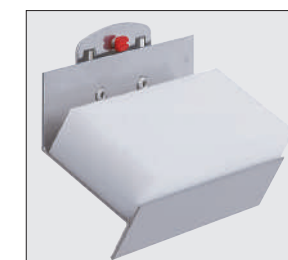

Portautensili per autoforatura

Cod. Art.	B	T
SGN-072	120mm	45mm
SGN-073	390mm	45mm

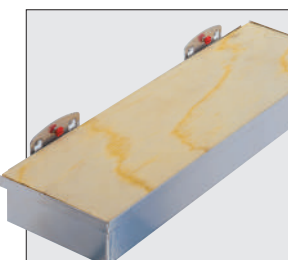

Box, piano in legno, autoforatura

Cod. Art.	
SGN-074	320 x 135 x 55mm

Accessori per pannelli perforati



Portautensili

Cod. Art.	
SGN-062	15 x Ø 17mm
SGN-063	12 x Ø 23mm

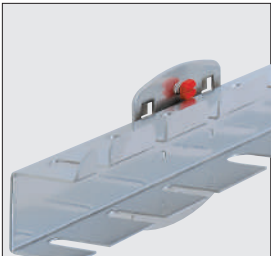

Portautensili
H 40 x B 200/390 x T 30mm

Cod. Art.	
SGN-064	per 6 pezzi
SGN-065	per 12 pezzi

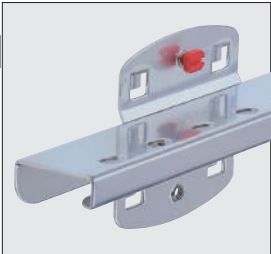

Porta-inserti
H 10 x B 150 x T 35mm

Cod. Art.	
SGN-066	per 7 pezzi

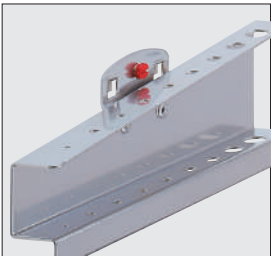

Porta-inserti
H 50/70 x B 200 x T 25mm

Cod. Art.	
SGN-067	per 9 pezzi



Porta-bussola
H 30 x B 390 x T 45mm

Cod. Art.	
SGN-068	per 12 pezzi



Porta-chiavi verticale
H 220 x B 145/75 x T 50mm

Cod. Art.	
SGN-069	per 10 pezzi



Porta-chiavi orizzontale
H 50 x B 130/60 x T 150mm

Cod. Art.	
SGN-071	per 8 pezzi



Portarotoli
● Grigio Chiaro

Cod. Art.	
SGN-075	H 170 X B 370 X T 320mm



Portarotoli
H 120 x B 355 x T 100mm

Cod. Art.	
SGN-076	



Portabottiglie e barattoli
H 50 x B 500 x T 80mm

Cod. Art.	
SGN-077	per 8 pezzi

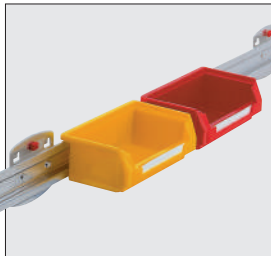

Porta-Bocche di Lupo - L 550/990mm

Cod. Art.	Misura 7 - H 58mm
SGN-078	per 5 pezzi
SGN-079	per 9 pezzi
Cod. Art.	Misura 8 - H 38mm
SGN-080	per 5 pezzi
SGN-081	per 9 pezzi



Porta-rotoli
300 mm, H 310 x B 384 x T 220mm
● Grigio Chiaro

Cod. Art.	
SGN-082	



Porta-chiavi verticale
H 255 x B 225/125 x T 50mm

Cod. Art.	
SGN-070	per 10 pezzi



Porta-cesto rifiuti, anello fissaggio
Ø 330mm, coperchio plastica blu
● Grigio Chiaro

Cod. Art.	
SGN-083	

Bracci telescopici in carbonio

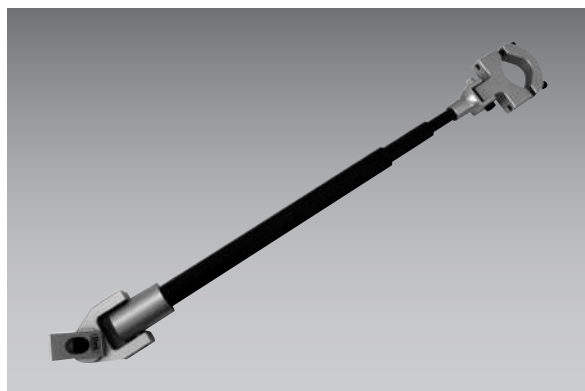

Braccio ergonomico telescopico in fibra di carbonio ideato per avere una migliore ergonomia e un minor affaticamento dell'operatore nelle postazioni di lavoro. Completa libertà di movimento durante l'utilizzo.

Disponibile sia per utensili diritti che a pistola.

Nota:
Per altre misure o forze contattare il nostro ufficio vendite.



Cod.	UT-BRT12	UT-BRT25
Coppia Max	12NM	25NM
Corsa	450-1000mm	450-950mm
Ø Attacco mm	28-40mm	30-50mm
Colori disponibili	01 02 04 05 09	
Prezzo €		

251

Bracci scorrevoli in alluminio

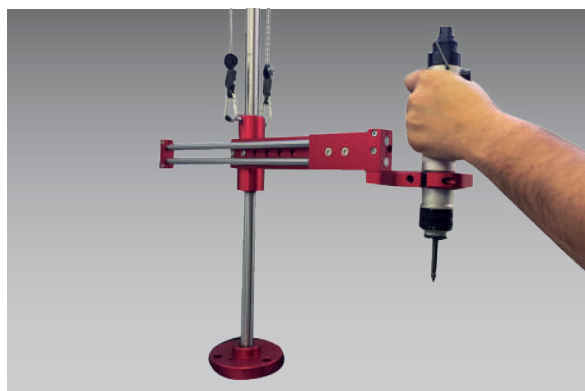

Braccio ergonomico scorrevole ideato per avere una migliore ergonomia e un minor affaticamento dell'operatore nelle postazioni di lavoro. Migliora la ripetibilità dell'avvitatore.

Nota:
Per altre misure o forze contattare il nostro ufficio vendite.



Cod.	UT-BRS25	UT-BRS75
Coppia Max	25NM	75NM
Corsa	395mm	210mm
Ingombro	260-460mm	205-355mm
Carico max Kg	10	10
Altezza	1000	1000
Ø Pinza mm	28-50	su richiesta
Prezzo €		

Ergonomia

UT-Box picking viterie

Il posizionamento ergonomico delle parti è essenziale per snellire e rendere più efficiente la produzione. I nostri UT-Box picking offrono una maggiore organizzazione della componentistica e uno stoccaggio consapevole della merce.

Grazie a questa organizzazione visiva si può tenere sotto controllo il rifornimento di ogni componente ed evitare sforzi fisici inutili.

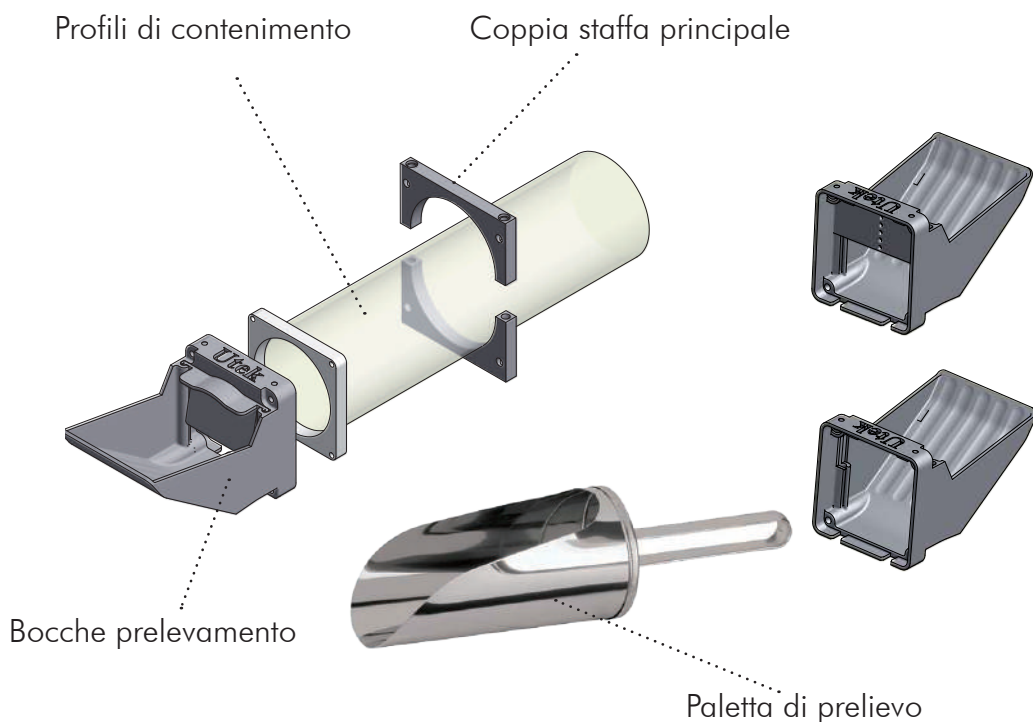

Componentistica

T72-300	Profili di contenimento D.Int.72mm L.300mm
T72-400	Profili di contenimento D.Int.72mm L.400mm
T72-500	Profili di contenimento D.Int.72mm L.500mm
T72-600	Profili di contenimento D.Int.72mm L.600mm
T72-700	Profili di contenimento D.Int.72mm L.700mm
T72-800	Profili di contenimento D.Int.72mm L.800mm
T72-900	Profili di contenimento D.Int.72mm L.900mm
T72-1000	Profili di contenimento D.Int.72mm L.10 00mm
M10	Maggiorazione 100mm
BP	Bocche prelevamento d.50/80mm
P72	Paletta prelievo per D.72mm
S-FIX72	Coppia staffa principale d.72mm

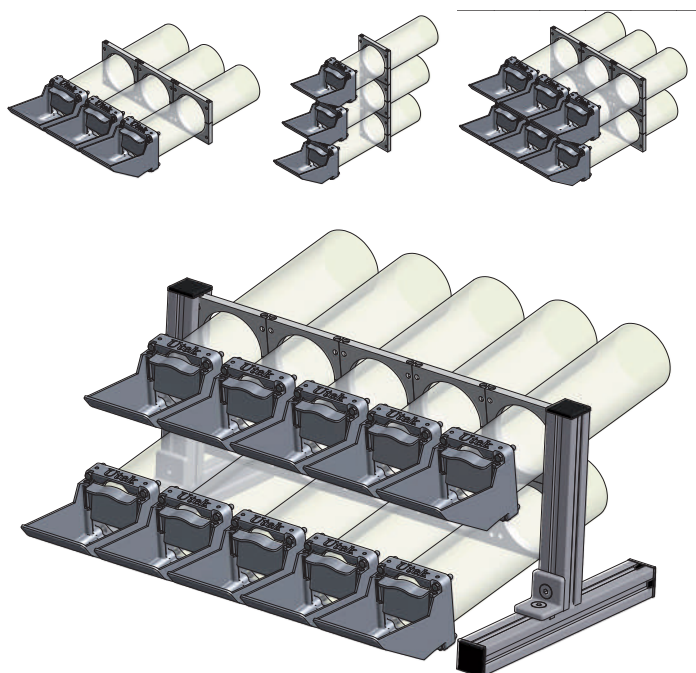



Caratteristiche

- Controllo del livello visibile;
- Differenti diametri e formati per componenti diversi;
- Proteggere i componenti dall'inquinamento provocato da fattori ambientali;
- Facile inserimento e rimozione dei componenti;
- Lunghezza variabile per consentire l'adeguamento ai più variegati prodotti;
- Slider per bloccare la fornitura dei componenti quando non in uso;
- Livelli KanBan regolabili in rosso, giallo e verde;
- Facile installazione su banchi da lavoro;
- Distribuzione componenti strutturata in modo definito e trasparente;
- Struttura fissa o girevole;
- Progettato per stimolare l'enfasi di lavoro dei dipendenti;
- Miglioramento della produttività attraverso la sicurezza dell'elevata precisione;
- Essenziale per l'asservimento frontale, elimina il ritorno del contenitore vuoto.



253



Ergonomia