

RACKING

BAUKASTENSYSTEM

www.utekvision.de

ROHRSYSTEME 28mm

ROHR 28mm

- ABS Beschichtung
- große Farbauswahl
- hohe Festigkeit

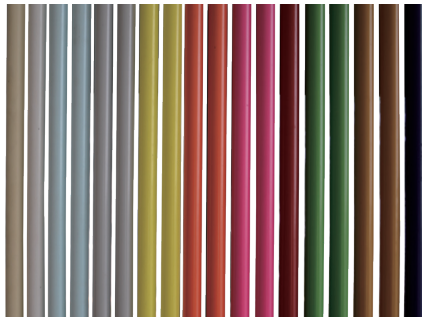

VORTEILE

- große Farbauswahl
- preiswert
- smart
- ultraleicht

Q-PIPE



Farben

WH BK IV GR GN BL RD

CODE	DICKE (stahl)	GEWICHT
LP-1100	1t	676g/m
LP-1200	2t	1.265g/m

ESD PIPE



Resistente Oberfläche $10^3 \Omega \sim 10^6 \Omega$

CODE	DICKE (stahl)	GEWICHT
CP-1100BK	1t	676g/m
CP-1200BK	2t	1.265g/m

SLIDE PIPE



IV GR

CODE	DICKE (stahl)	GEWICHT
SL-1100	1t	767g/m

ROSTFREI



CODE	DICKE (stahl)	GEWICHT
ST-1110 (201)	1t	734g/m

ALU



CODE	DICKE (stahl)	GEWICHT
AL-1150	1,5t	380g/m

KOHLEFASER PIPE



CODE	DICKE (stahl)	GEWICHT
CBP-1200BK	2t	1.265g/m

ROHRSYSTEME 28mm

ROLLSCHIENEN, SEITENFÜHRUNGEN, BEFESTIGUNGSELEMENTE

PL-4014WH

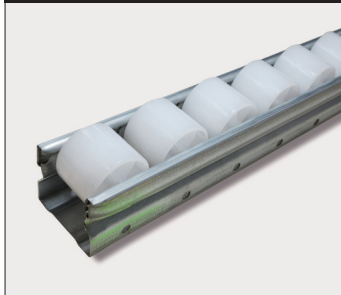

PL-4014GR



PL-4014ESD



PL-4011BD

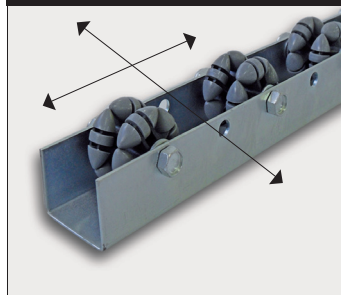

PL-7314WS



PL-7314ESD



UT-SUP



PL-G100TS



PM-4010A



PM-4010B



PM-4010BW



PM-4012A



PM-7310A

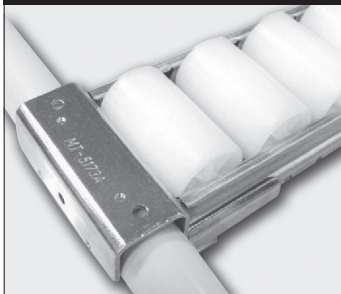

PM-7310B

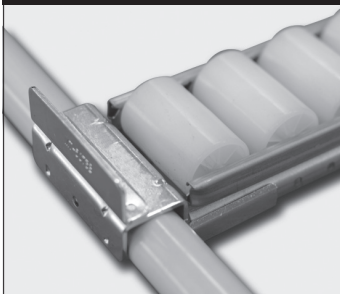

PM-7310X

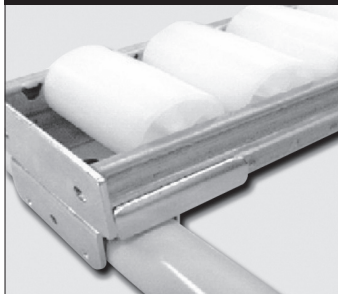

MS-7318SV



PA-401A

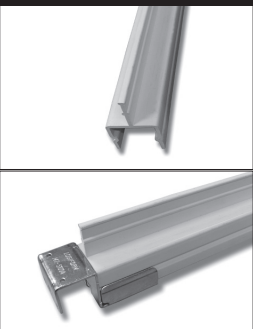

PA-402B



PA-403C



PA-404D



PA-405E



ROHRSYSTEME 28mm

VERBINDER

H-1 (MJ-2101BK)



•240stk/VE •72g/stk

H-1B (MJ-2201BK)



•240stk/VE •62g/stk

H-2 (MJ-2102BK)



•150stk/VE •96g/stk

H-3 (MJ-2103BK)



•70stk/VE •122g/stk

H-4 (MJ-2104BK)



•180stk/VE •112g/stk

H-5 (MJ-2105BK)



•300stk/VE •44g/stk

H-6 (MJ-2106BK)



•300stk/VE •54g/stk

H-6B (MJ-2206BK)



•300stk/VE •52g/stk

H-7 (MJ-2107BK)



•180stk/VE •50g/stk

H-7B (MJ-2207BK)



•180stk/VE •40g/stk

H-8 (MJ-2108BK)



•300stk/VE •52g/stk

H-9 (MJ-2109BK)



•100stk/VE •140g/stk

H-10 (MJ-2110BK)



•180stk/VE •60g/stk

H-11 (MJ-2111BK)



•200stk/VE •64g/stk

H-11B (MJ-2211BK)



•200stk/VE •54g/stk

VERFÜGBAR



SCHWARZ
(MJ-2101BK)



CHROM
(MJ-2101SV)



NICKELPLATTIERUNG
(MJ-2101NI)

RORSYSTEME 28mm

VERBINDER

H-12 (MJ-2112)



•200stk/VE •60g/stk

H-13 (MJ-2113)



•140stk/VE •92g/stk

H-14 (MJ-2114)



•150stk/VE •78g/stk

H-15A (MJ-2115BK)



•300stk/VE •44g/stk

H-15B (MJ-2215BK)



•300stk/VE •38g/stk

H-16 (MJ-2116BK)



•300stk/VE •50g/stk

H-16B (MJ-2216BK)



•300stk/VE •50g/stk

H-17 (MJ-2117BK)



•180stk/VE •66g/stk

H-18 (MJ-2118BK)



•240stk/VE •66g/stk

H-19 (MJ-2219BK)



•270stk/VE •62g/stk

H-20 (MJ-2120BK)



•150stk/VE •94g/stk

H-21 (MJ-2121BK)



•150stk/VE •101g/stk

H-45A (MJ-2145BK)



•140stk/VE •60g/stk

H-45B (MJ-2245BK)



•140stk/VE •60g/stk

H-108 (MJ-21108BK)



•140stk/VE •92g/stk

H-162 (MJ-21162BK)



•180stk/VE •92g/stk

ROHRSYSTEME 45X45mm

GRUNDRAHMEN

VERFÜGBAR: SCHWARZ

HIGH LOAD AND MILKRUN

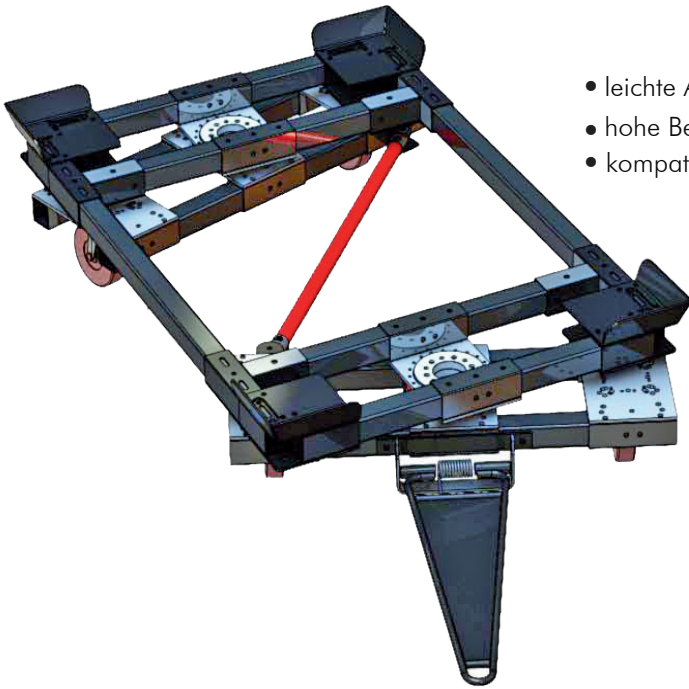

- leichte Anwendung
- hohe Belastung
- kompatibel

BR-4545-T2



BR-01

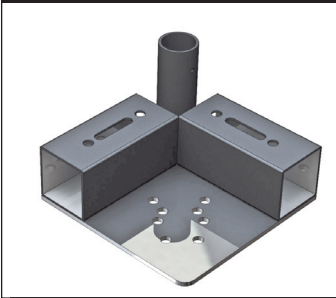

BR-02

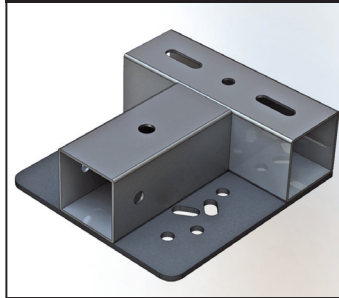

BR-03

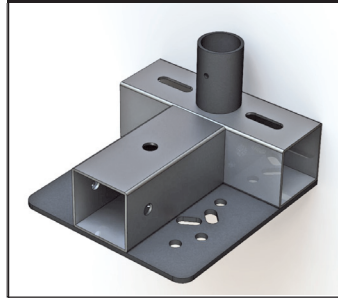

BR-04



MT-5100

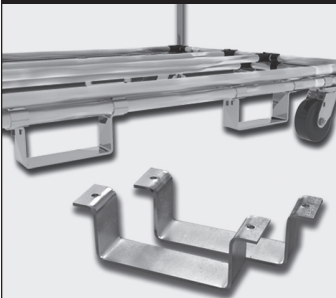

BR-06



BR-08

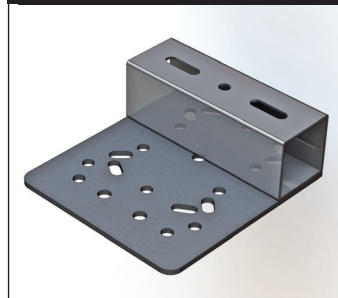

BR-10

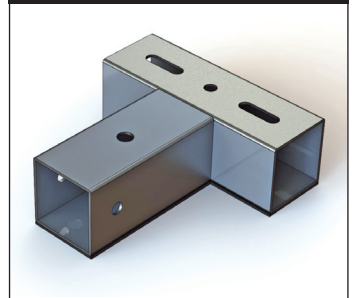

BR-11



BR-13



BR-14

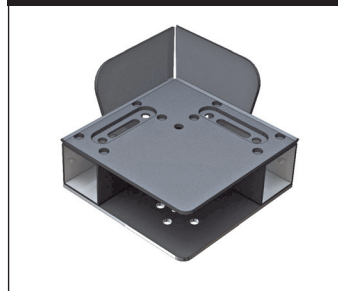

MT-5148 (4''-5''-6'')



ROHRSYSTEME 45X45mm

GRUNDRHMEN

BQ-01

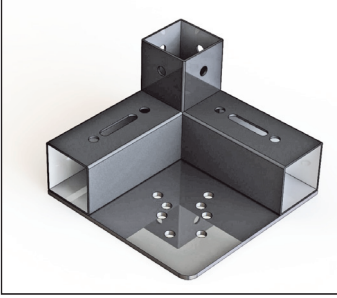

BQ-02

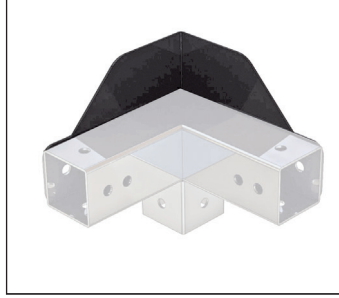

BQ-03

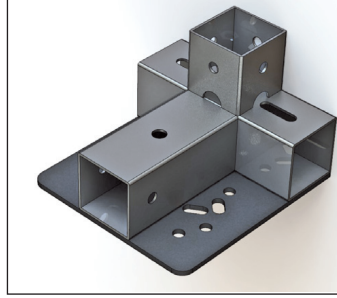

BQ-04

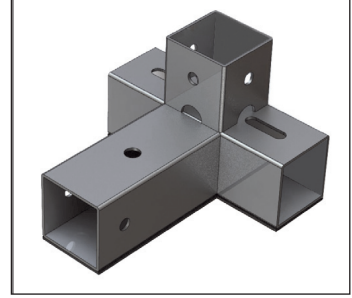

BQ-06

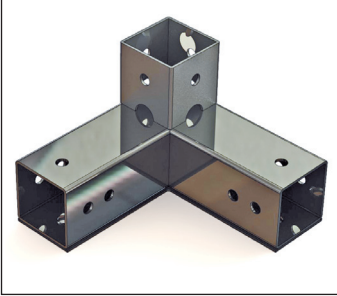

BQ-07

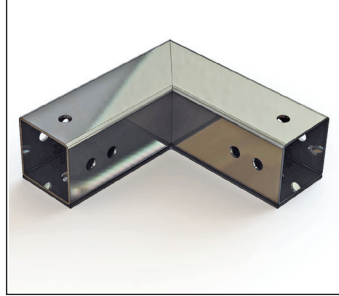

BQ-08

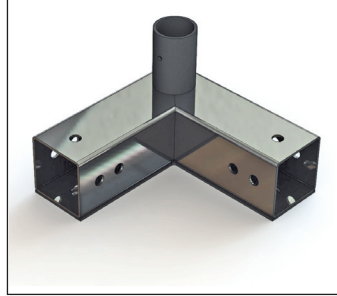

BQ-09

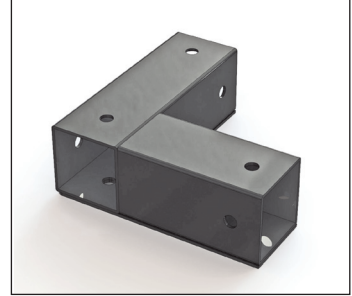

BQ-10

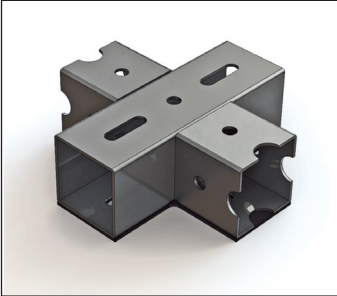

BQ-11

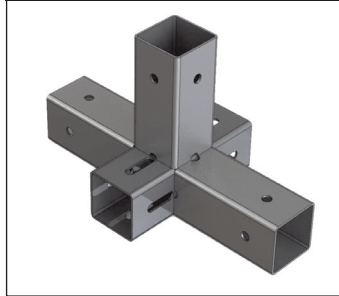

BQ-12

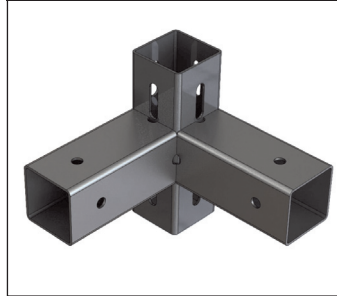

BQ-013

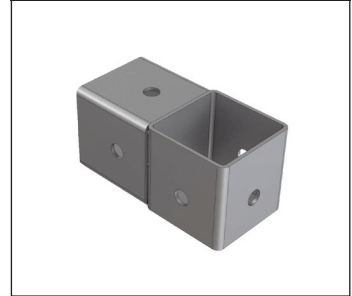

BQ-14



BQ-15



BQ-16



BQ-17



BQ-19



BQ-M12



BQ-TP

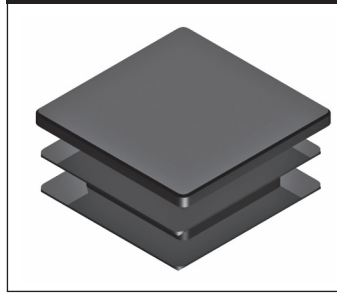

BQ-130

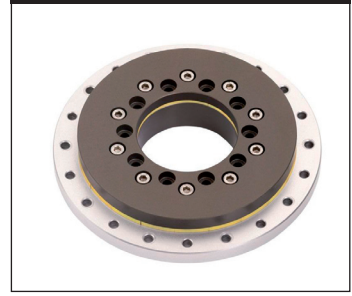

ROHRSYSTEME 28mm

Verfügbar: eloxiert



ASP-1200



Utek srl - Via Luciano Lama, 8 - Villa Argine
42023 Cadelbosco di Sopra (RE) - Italy
Tel. +39.0522.958945 - Fax +39.0522.912181
infoutekvision.com - www.utekvision.com

Utek Deutschland - Germany
kontakt@utekvision.de - www.utekvision.de